

AL-AS70FD
Diffuser

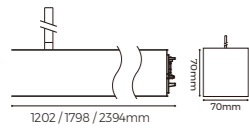

AL-BS70FD

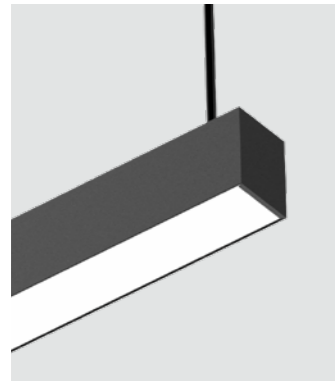
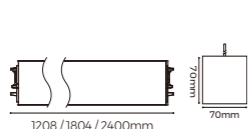

AL-CS70FD

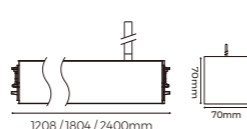

AL-DS70FD

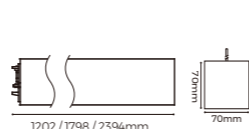
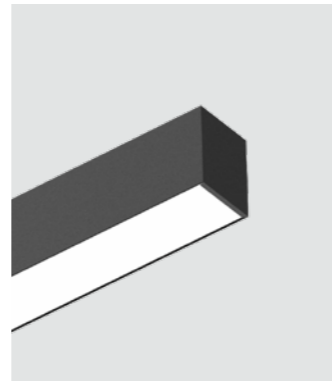

AL-AS70FP
Prismatic

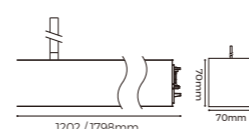
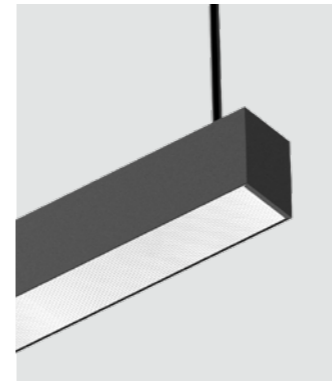

AL-BS70FP

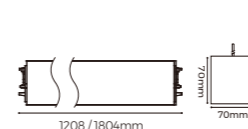
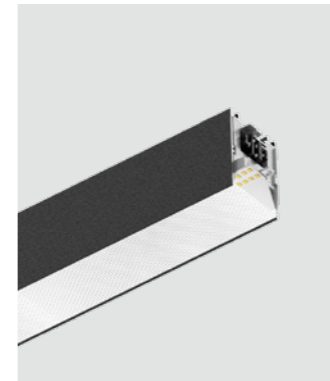

AL-CS70FP

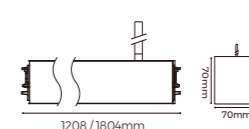

AL-DS70FP

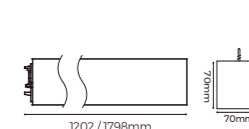
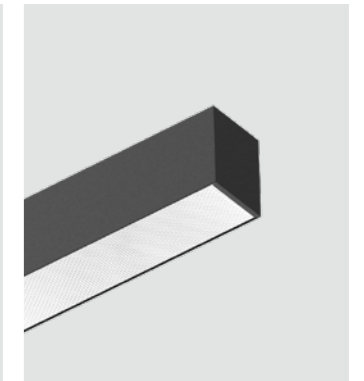

Dimming Method



Basic Parameters

Installation	Pendant, Ceiling
Lighting direction	Downward
Material	AL6063-T5
Coating	Spraying surface
Colors	Matt black / Matt white
Input voltage	AC220-240V
Application	Indoor
IP grade	IP20
Warranty	5 years
Certification	CE / UKCA / Rohs / Reach

Luminaire Parameters

Light source	2835
SDCM	≤3 Step(ANSI)
CRI	80 / 90
CCT	2700 / 3000 / 4000 / 6500 / 3CCT Dial Switch ⁽¹⁾
Length (mm)	1200 / 1800 / 2400
Power(W)	47 / 70 / 90
Luminous flux (lm) (Normal)	5405 / 8050 / 10350
Light efficiency(LM/W) (Normal)	115
Luminous flux (lm) (High-efficiency)	6345 / 9450 / 12150
Light efficiency(LM/W) (High-efficiency)	135
Luminous flux (lm) (Normal-3CCT)	5640 / 8400 / 10800
Light efficiency(LM/W) (Normal-3CCT)	120

Luminous flux (lm) (High-efficiency-3CCT) 6580 / 9800 / 12600

Light efficiency(LM/W) (High-efficiency-3CCT) 140

Beam angle 100°

* The above parameters are based on Ra80, 4000K white luminaires.
⁽¹⁾ The color temperature range of the 3CCT dial switch is 3000K / 4200K / 6500K

Installation Accessories

Pendant cable	PN(E)-D
Flexible diffuser	CV-AS35FD

Optical Parameter - Normal

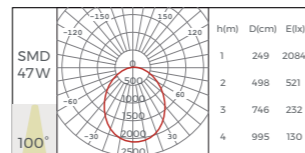

Optical Parameter - High efficiency

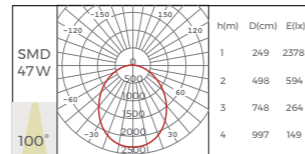

Normal-3CCT Dial Switch

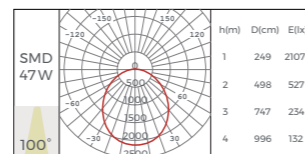

High efficiency-3CCT Dial Switch

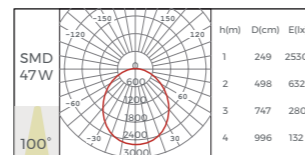

Dimming Method



Basic Parameters

Installation	Pendant, Ceiling
Lighting direction	Downward
Material	AL6063-T5
Coating	Spraying surface
Colors	Matt black / Matt white
Input voltage	AC220-240V
Application	Indoor
IP grade	IP20
Warranty	5 years
Certification	CE / UKCA / Rohs / Reach

Luminaire Parameters

Light source	2835
SDCM	≤3 Step(ANSI)
UGR	<19 (X=4H, Y=8H)
CRI	80 / 90
CCT	2700 / 3000 / 4000 / 6500 / 3CCT Dial Switch ⁽¹⁾
Length (mm)	1200 / 1800
Power(W)	47 / 70
Luminous flux (lm) (Normal)	4935 / 7350
Light efficiency(LM/W) (Normal)	105
Luminous flux (lm) (High-efficiency)	5875 / 8750
Light efficiency(LM/W) (High-efficiency)	125
Luminous flux (lm) (Normal-3CCT)	5405 / 8050
Light efficiency(LM/W) (Normal-3CCT)	115

Luminous flux (lm) (High-efficiency-3CCT) 6345 / 9450

Light efficiency(LM/W) (High-efficiency-3CCT) 135

Beam angle 70°

* The above parameters are based on Ra80, 4000K white luminaires.
⁽¹⁾ The color temperature range of the 3CCT dial switch is 3000K / 4200K / 6500K

Installation Accessories

Pendant cable	PN(E)-D
---------------	---------

Optical Parameter - Normal

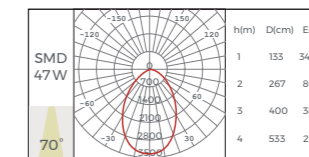

Optical Parameter - High efficiency

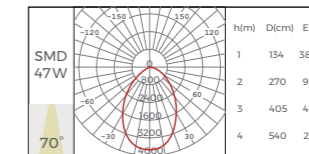

Normal-3CCT Dial Switch

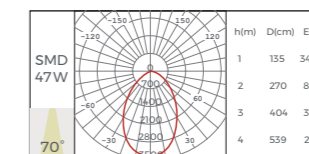

High efficiency-3CCT Dial Switch

